

Name: _____

**BASIC OVOID
WORKSHEET "a"**

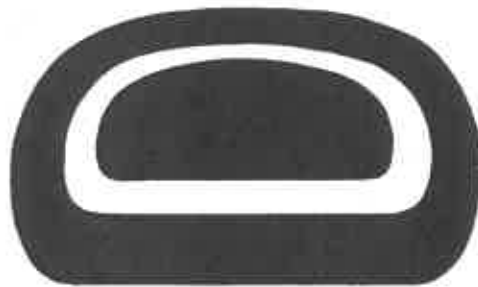

Connect the dots.

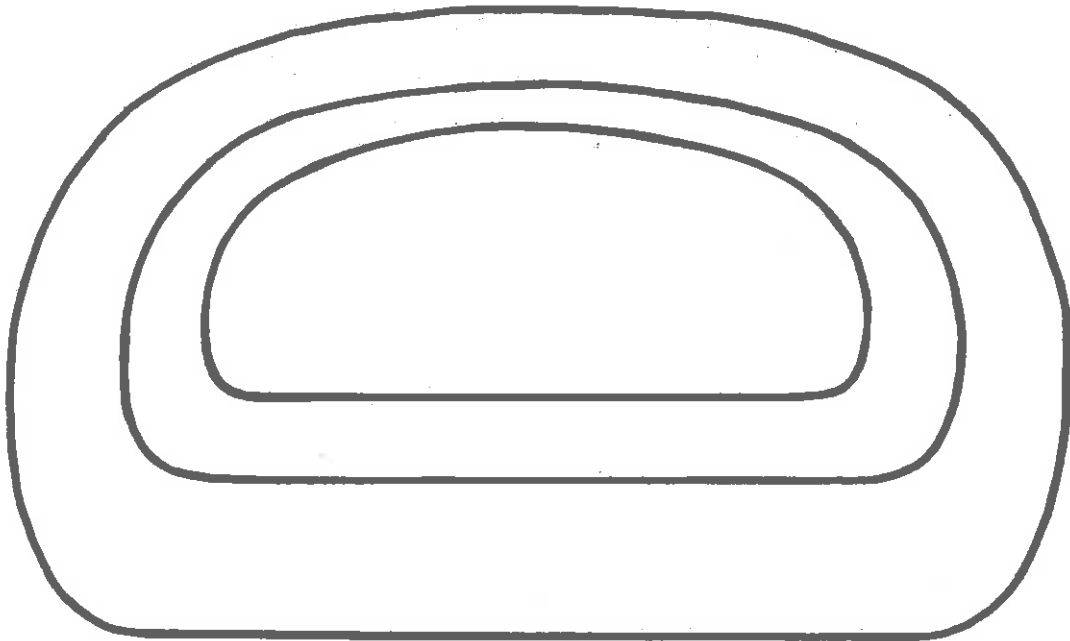
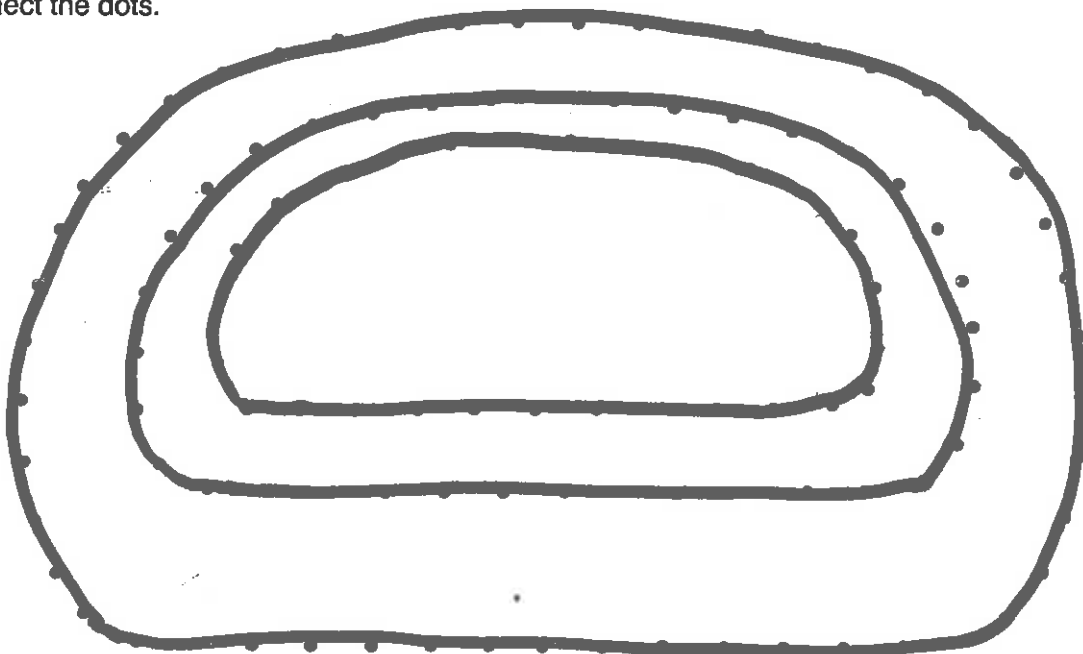

Name: _____

**BASIC OVOID
WORKSHEET "b"**

Fill in the missing lines.

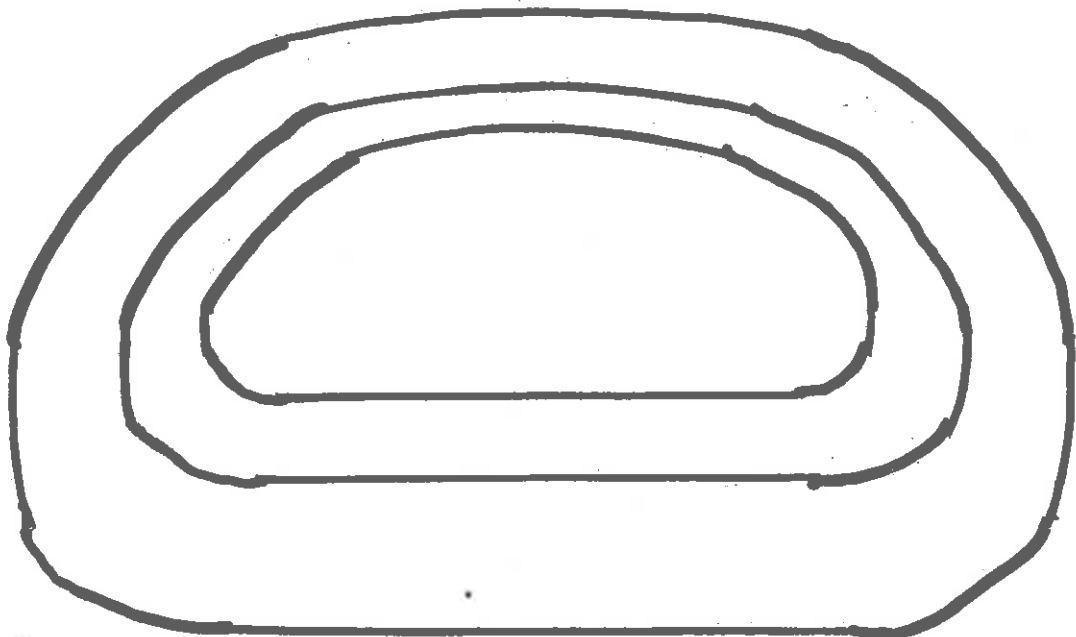
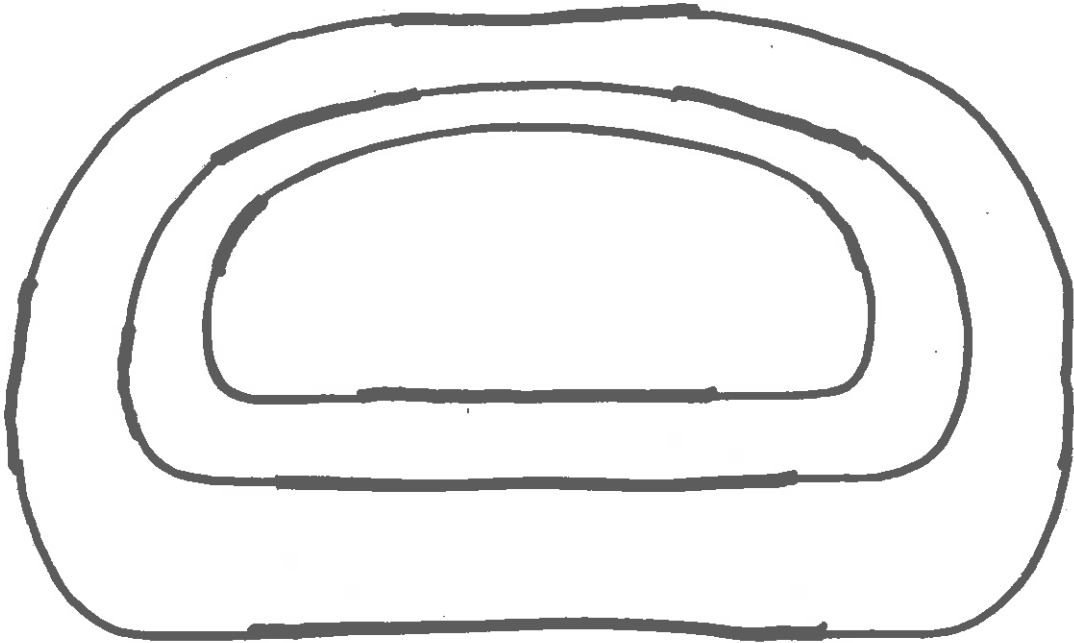

Name: _____

**BASIC OVOID
WORKSHEET "c"**

Draw in the missing half.

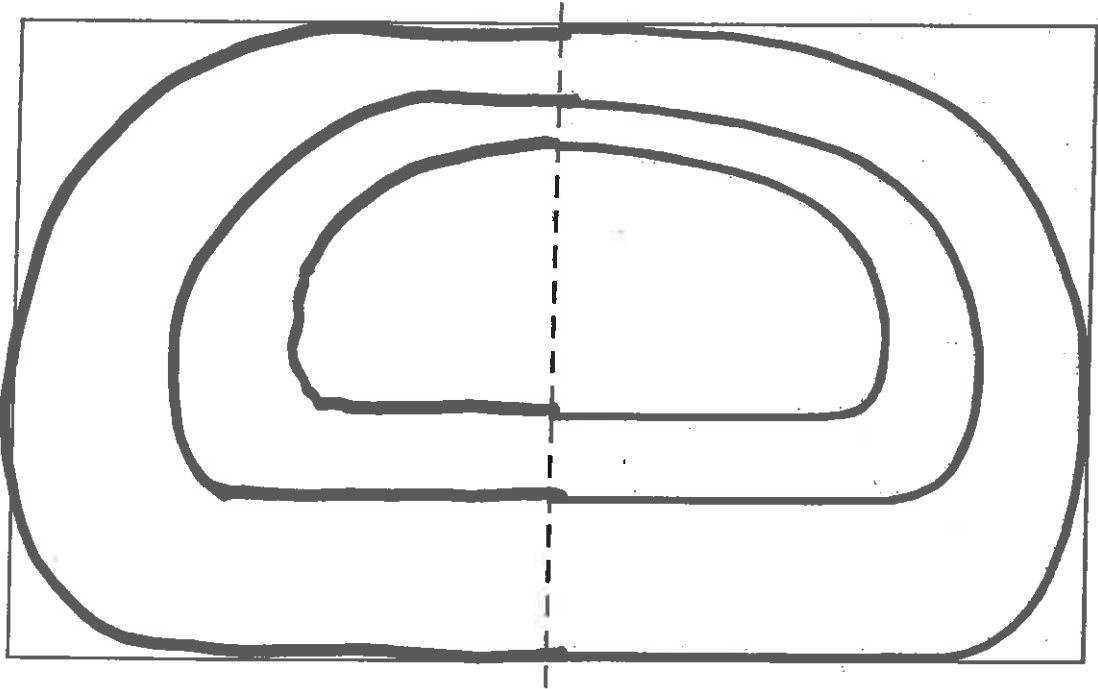

Name: _____

OVOID WITH EYELID LINE WORKSHEET "a"

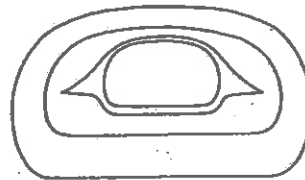
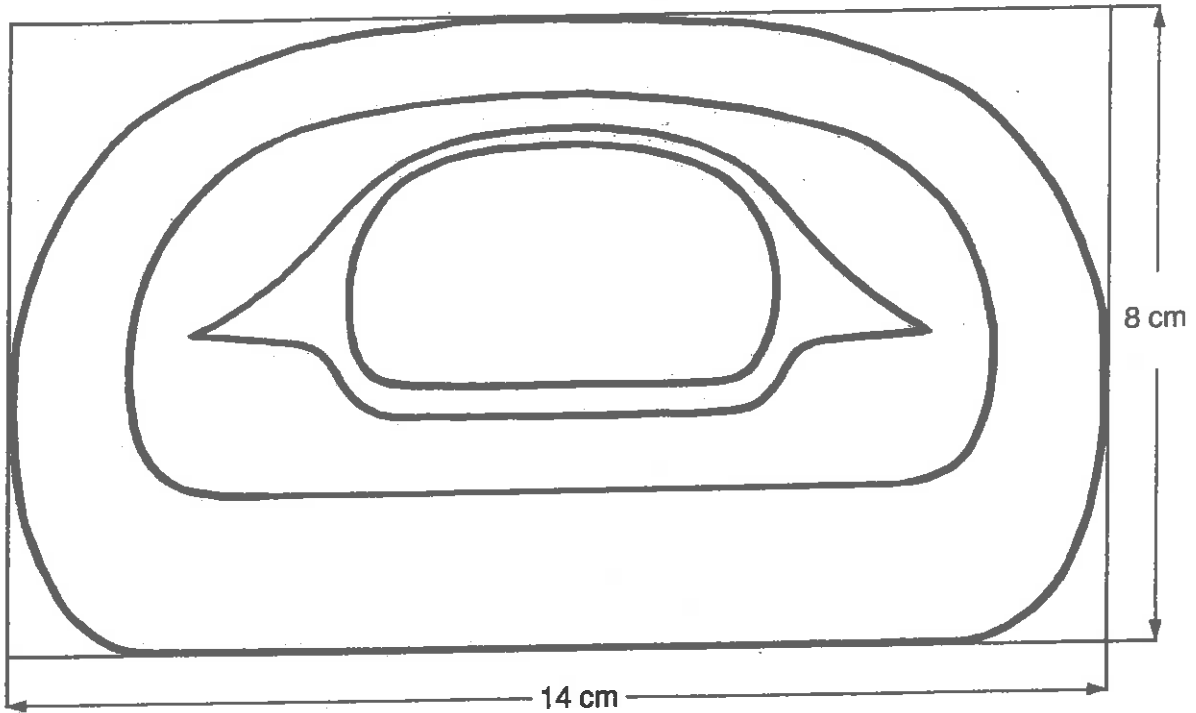

Connect the dots

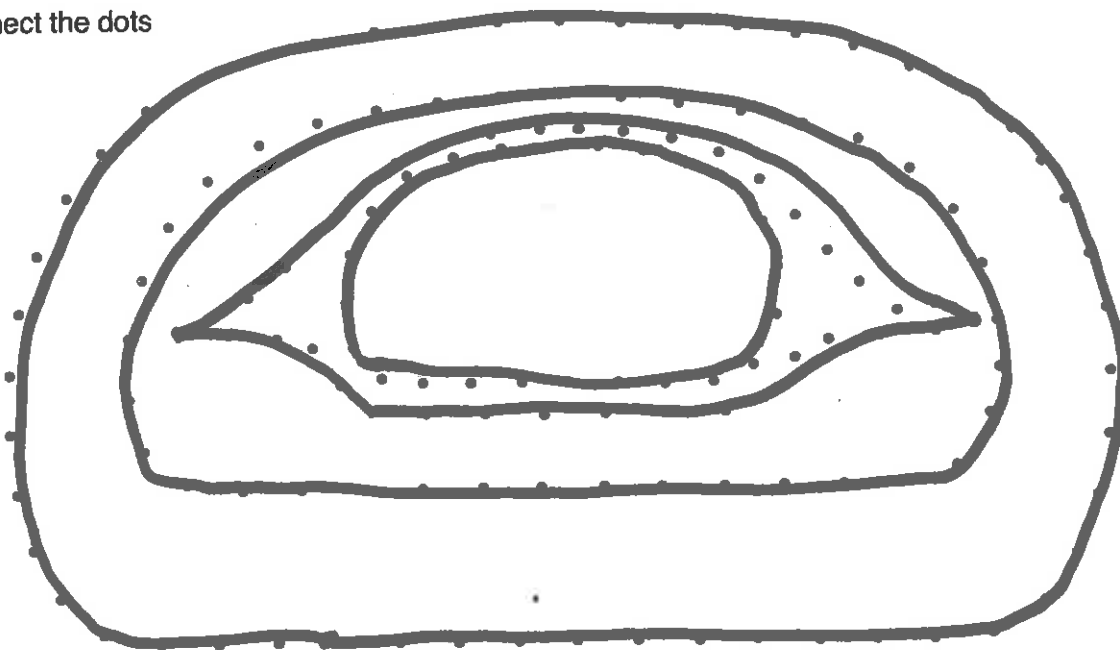

Name: _____

OVOID WITH EYELID LINE WORKSHEET "b"

Fill in the missing lines.

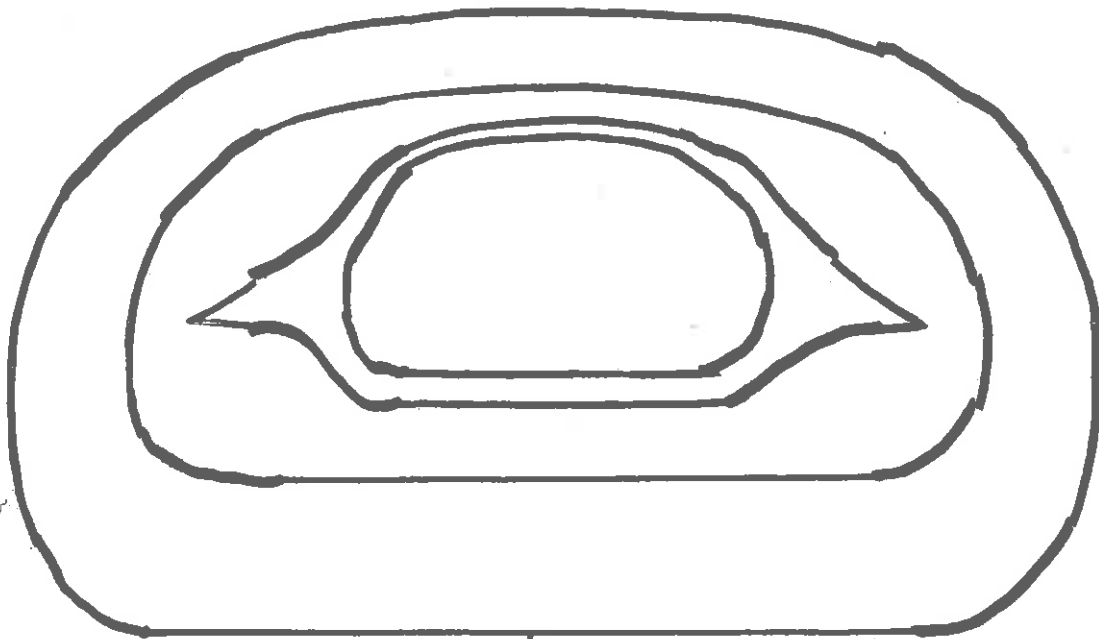
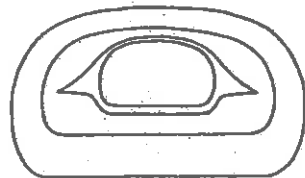
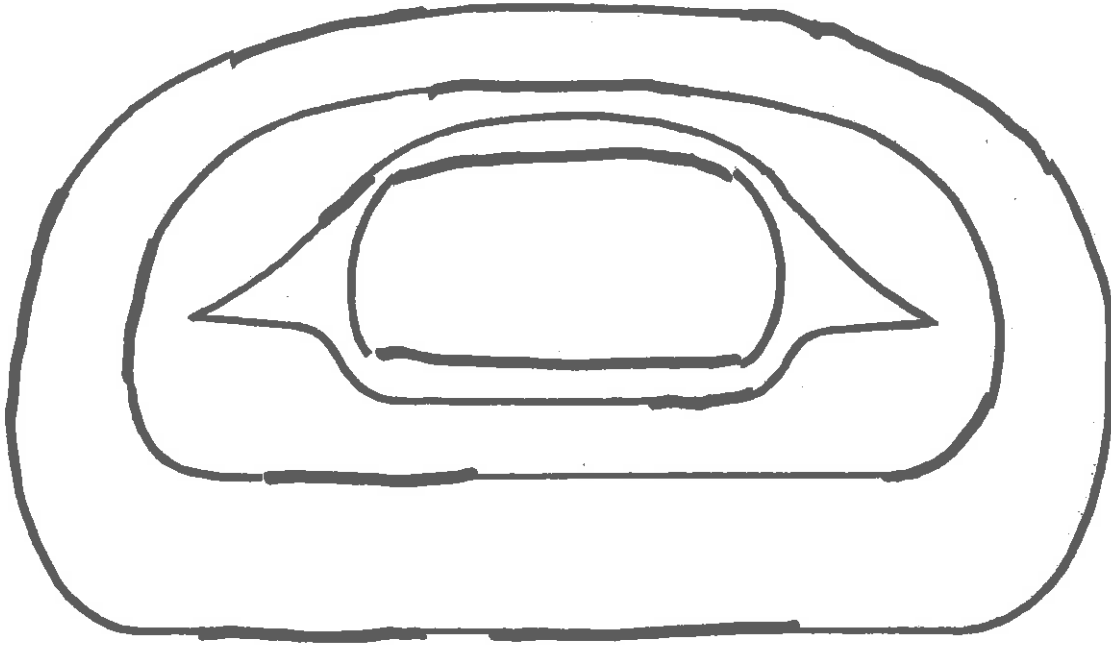

Name: _____

'U' SHAPE WORKSHEET "a"

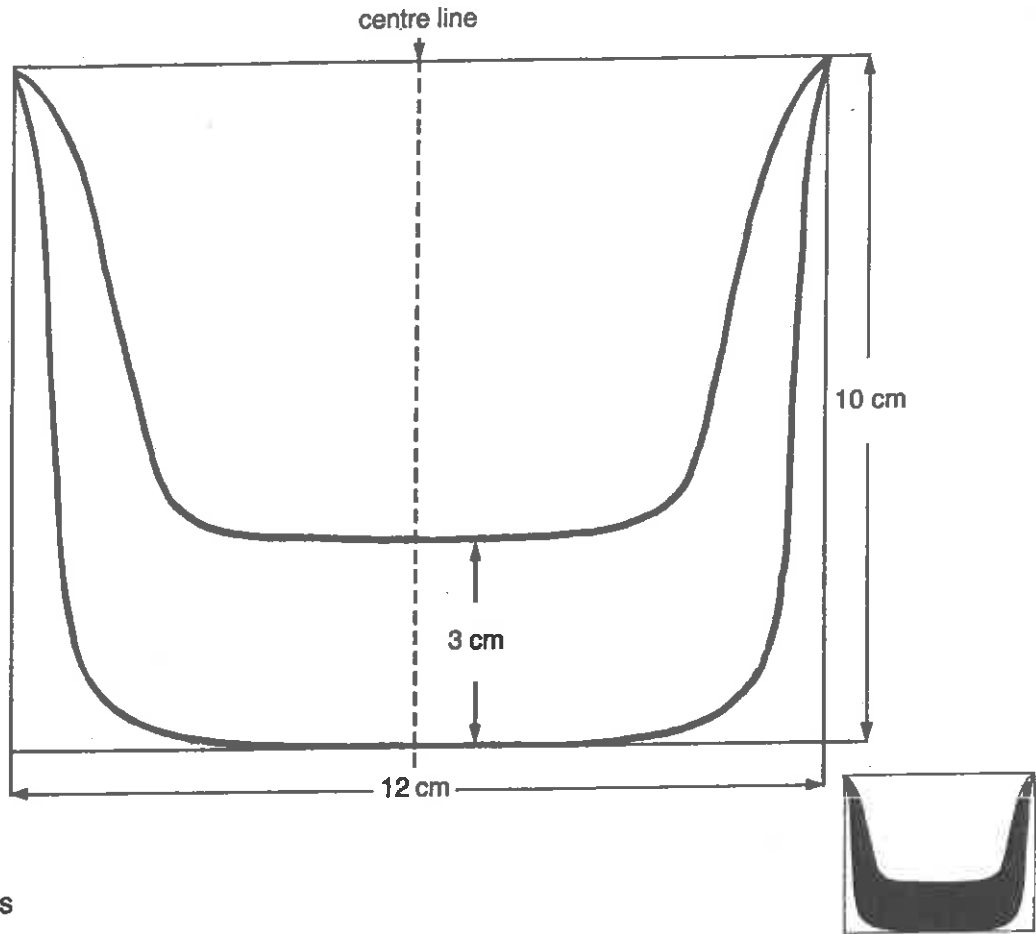

Connect the dots

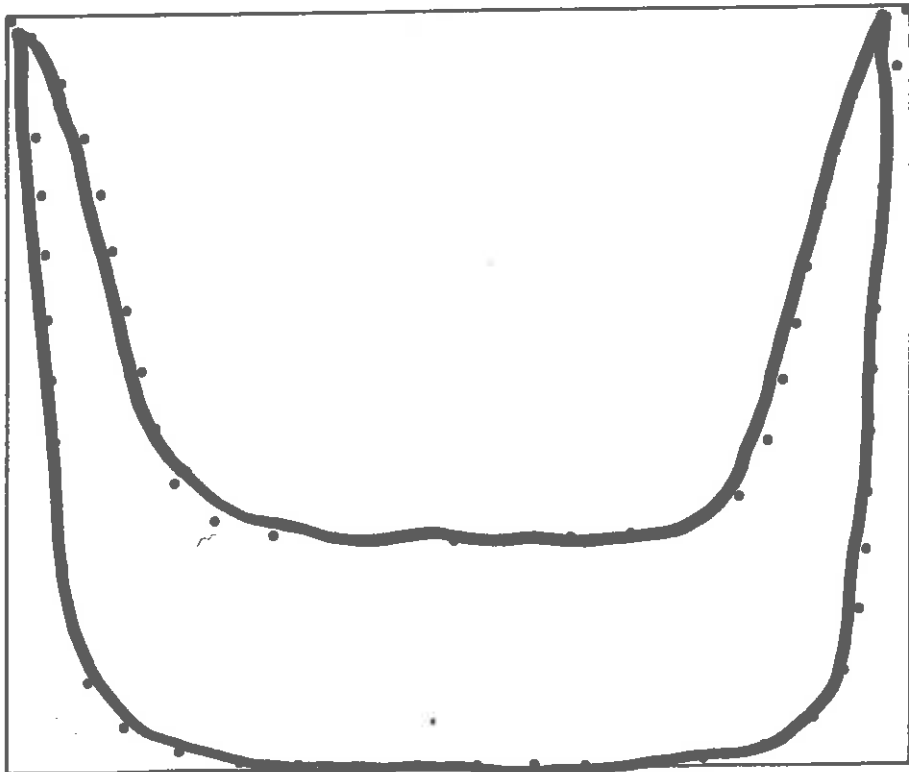

Name: _____

**'U' SHAPE
WORKSHEET "b"**

Fill in the missing lines.

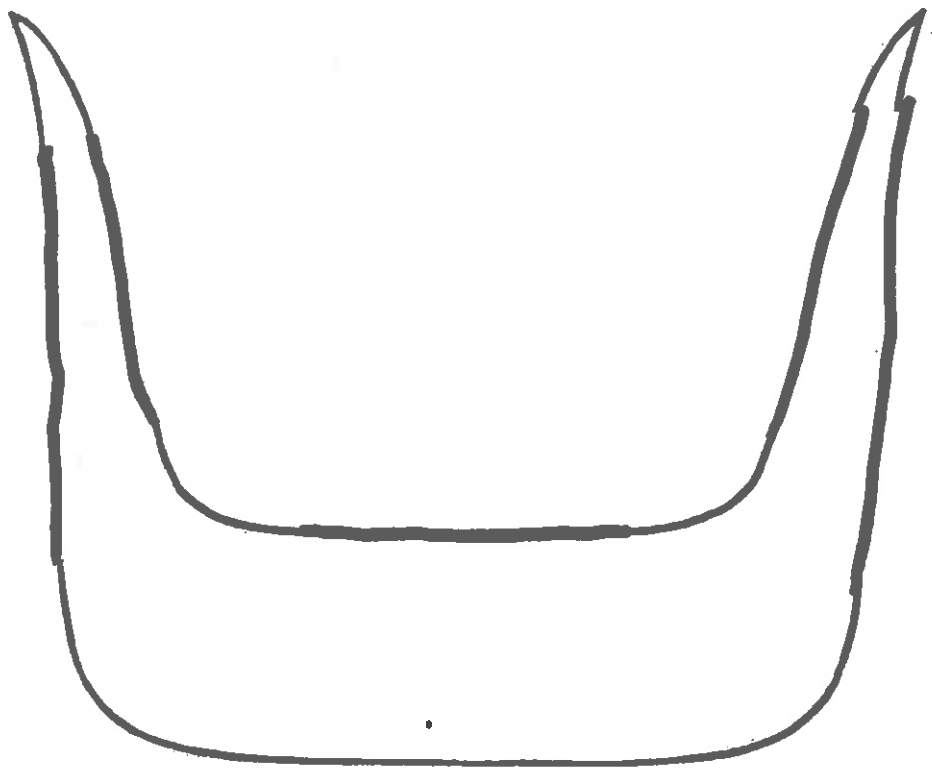
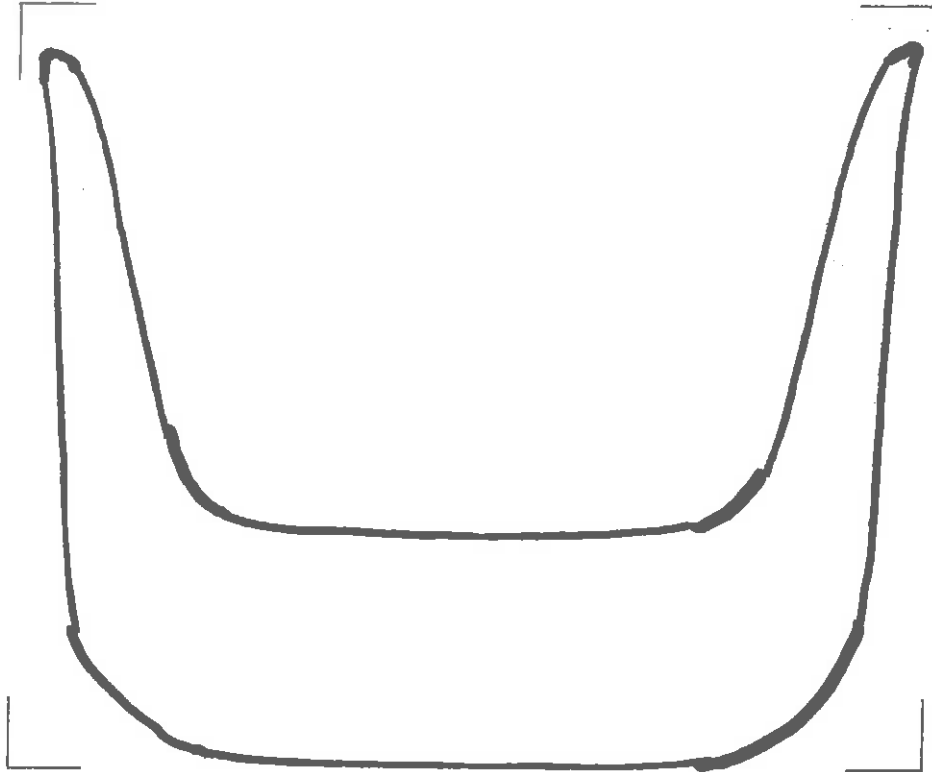

Name: _____

SPLIT 'U' WORKSHEET "a"

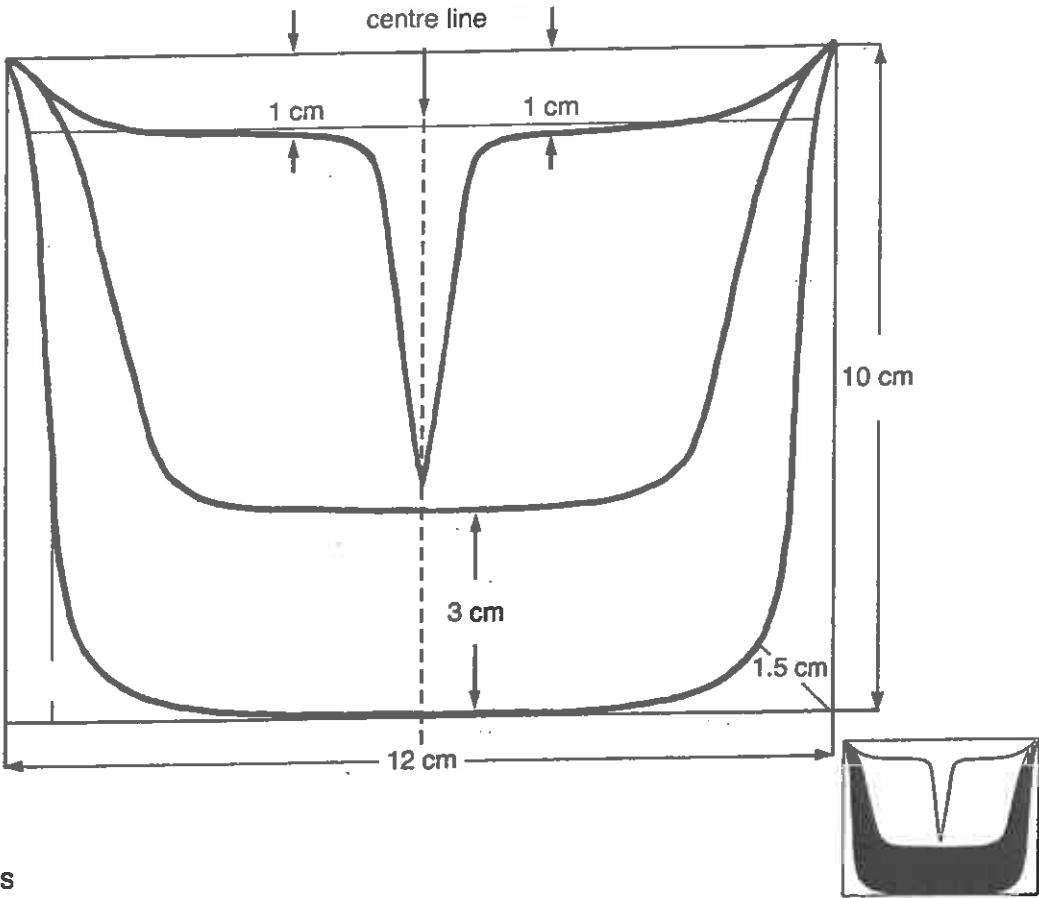

Connect the dots

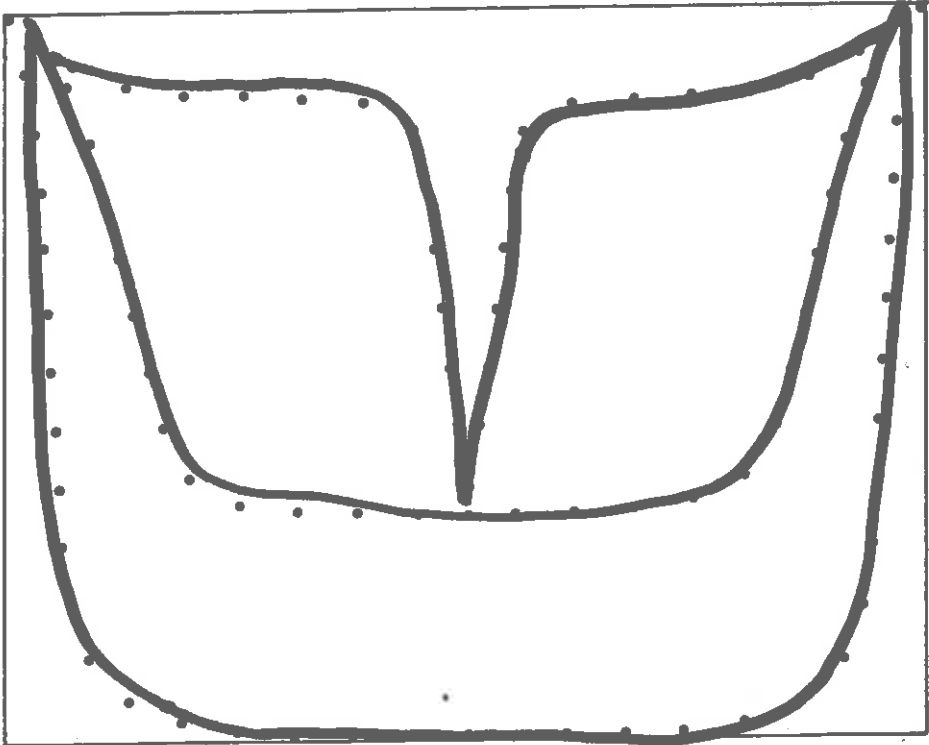

Name: _____

SPLIT 'U'
WORKSHEET "b"

Fill in the missing lines

