

COMPLETED WHALE FIGURE

Identify ovoids.

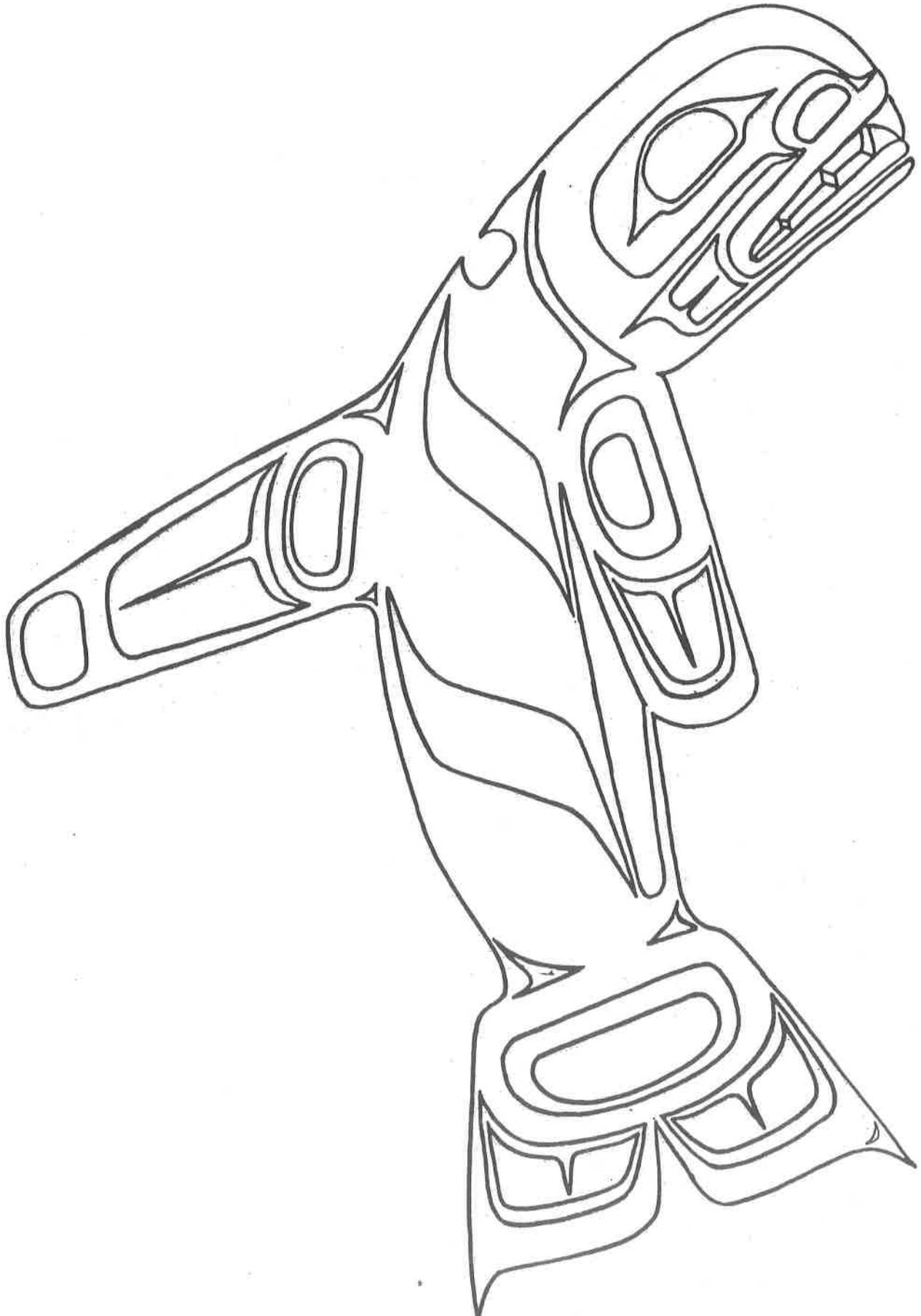

Name: _____

**BASIC OVOID
WORKSHEET "a"**

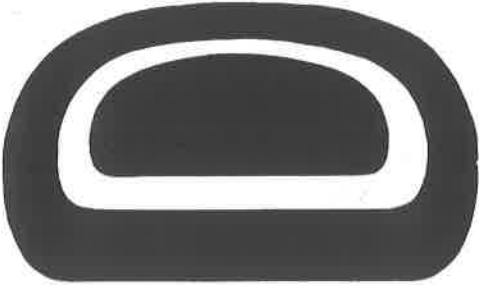
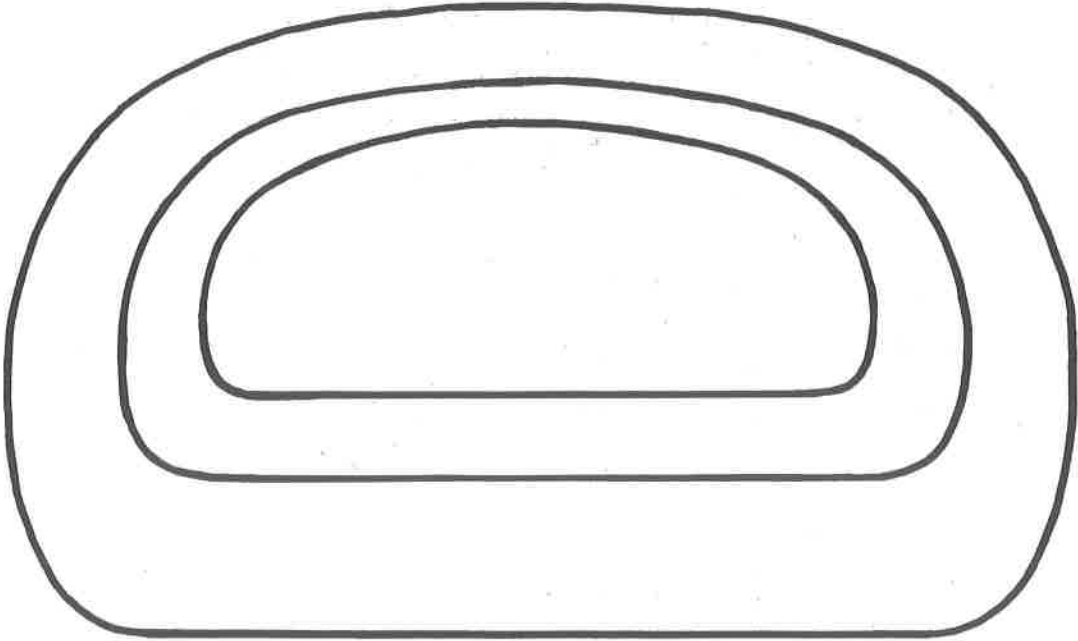

Connect the dots.

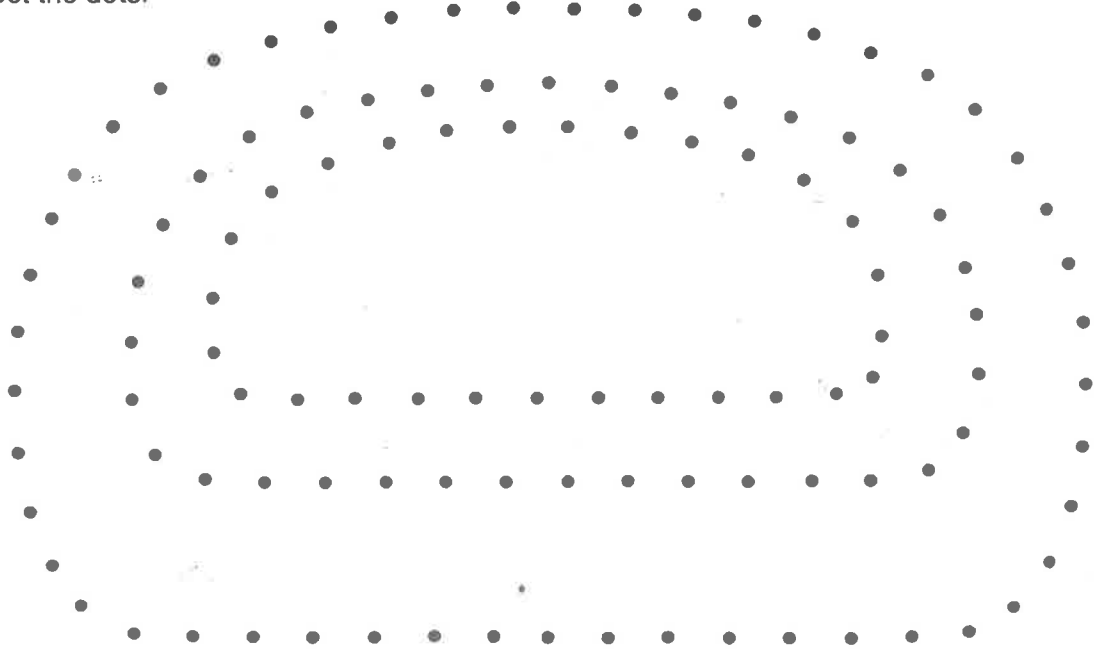

Name: _____

BASIC OVOID WORKSHEET "b"

Fill in the missing lines.

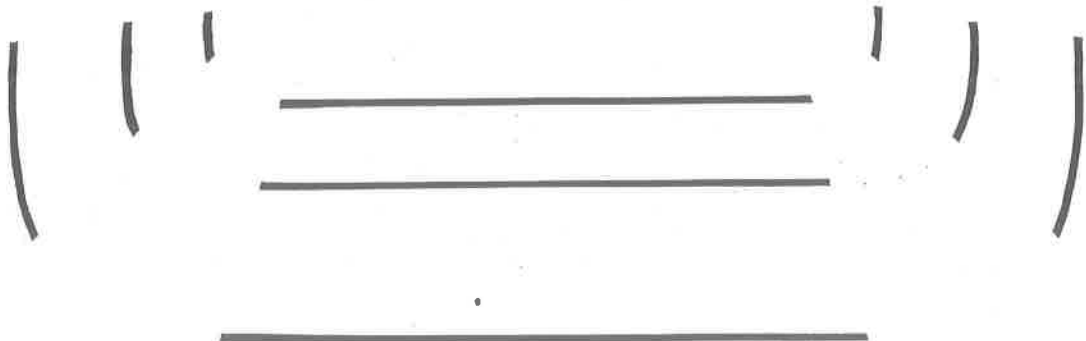
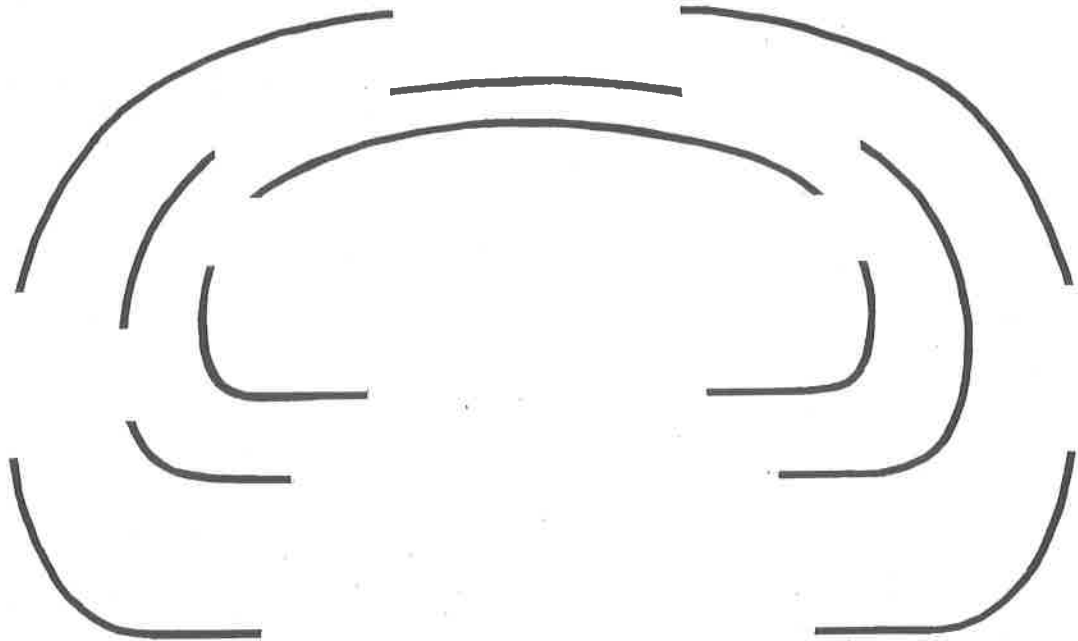

Name: _____

**BASIC OVOID
WORKSHEET "c"**

Draw in the missing half.

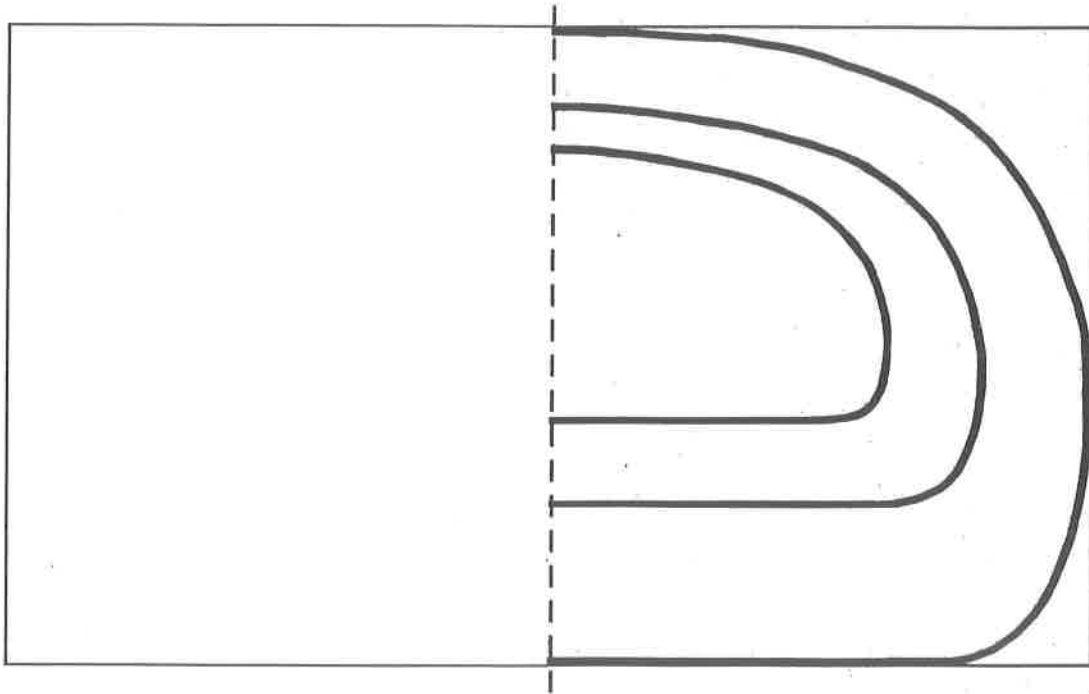

Name: _____

OVOID WITH EYELID LINE WORKSHEET "a"

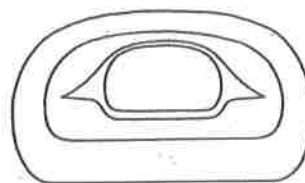
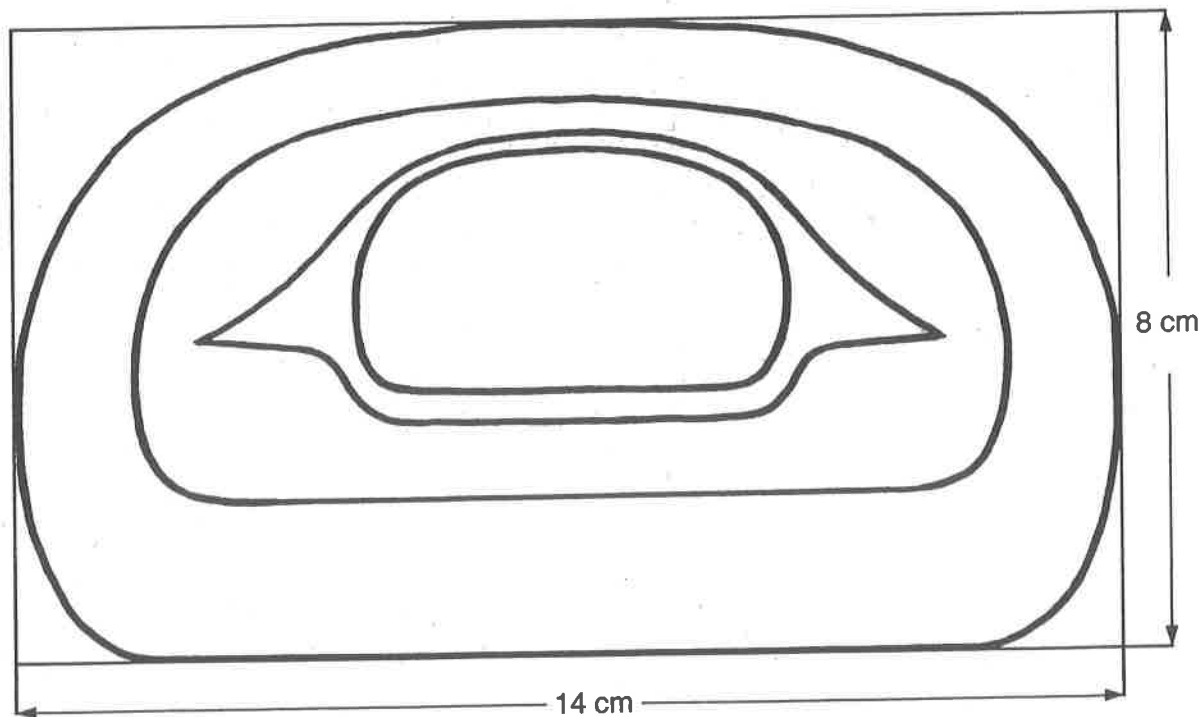

Connect the dots

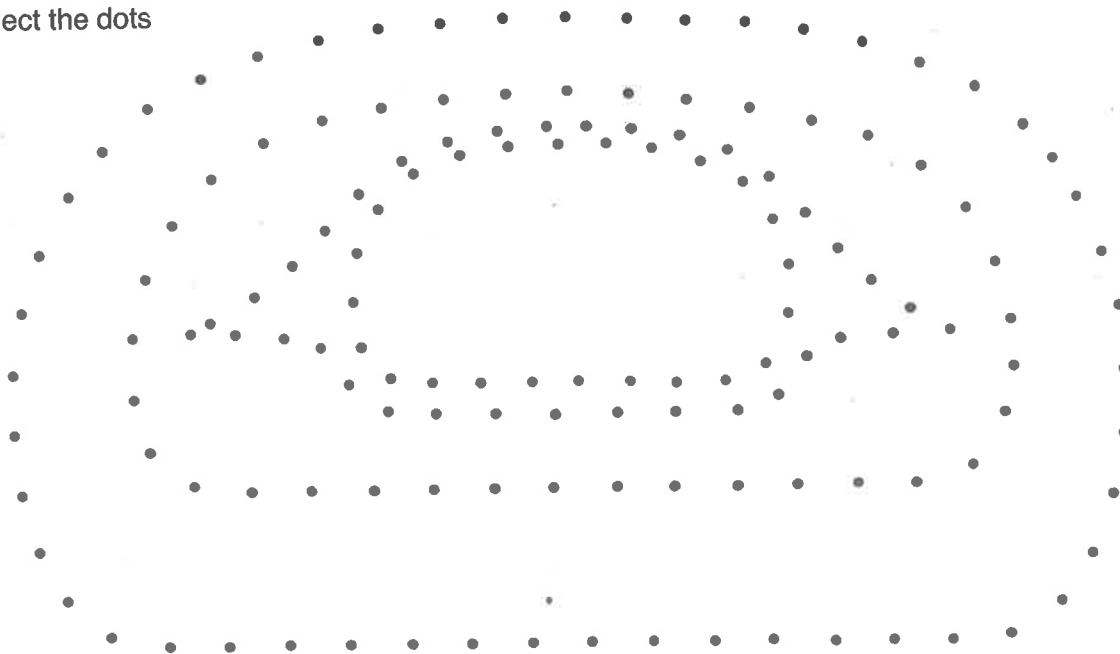

Name: _____

OVOID WITH EYELID LINE WORKSHEET "b"

Fill in the missing lines.

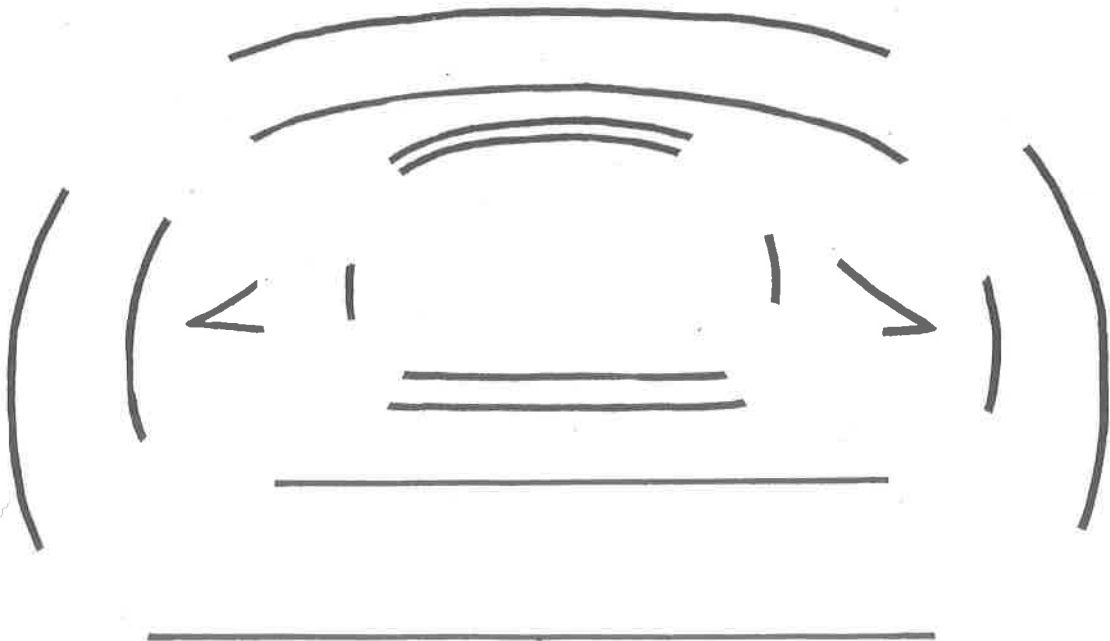
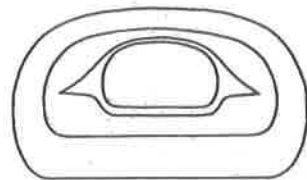
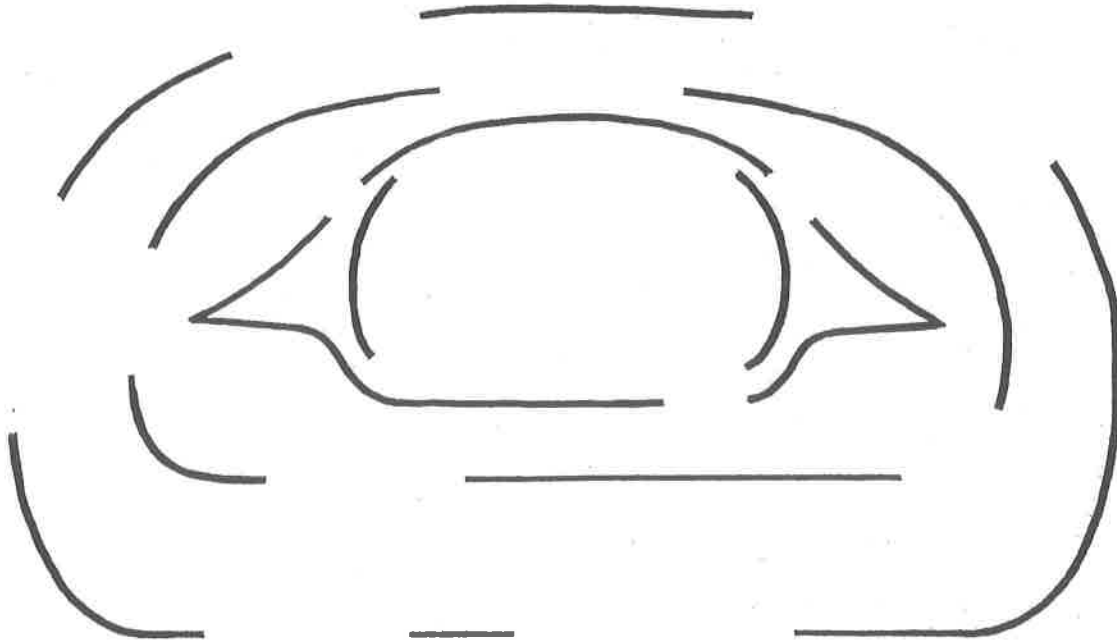

Name: _____

VOID WITH EYELID LINE WORKSHEET "c"

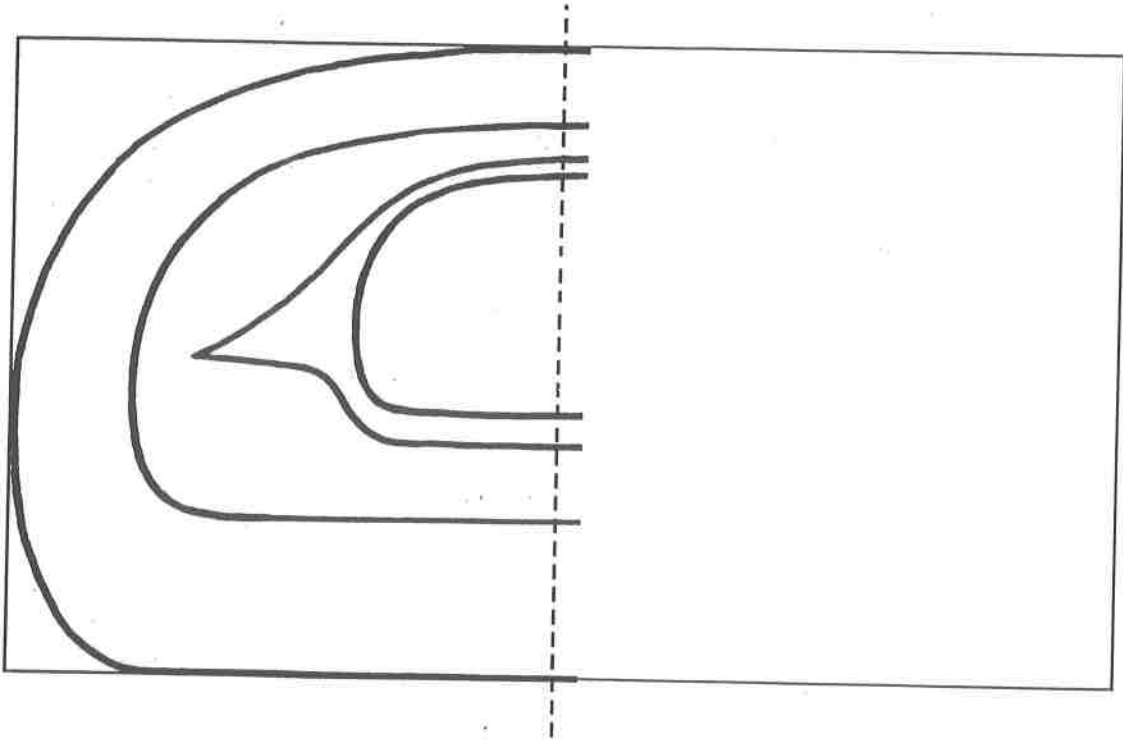

Complete using reference dots and lines.

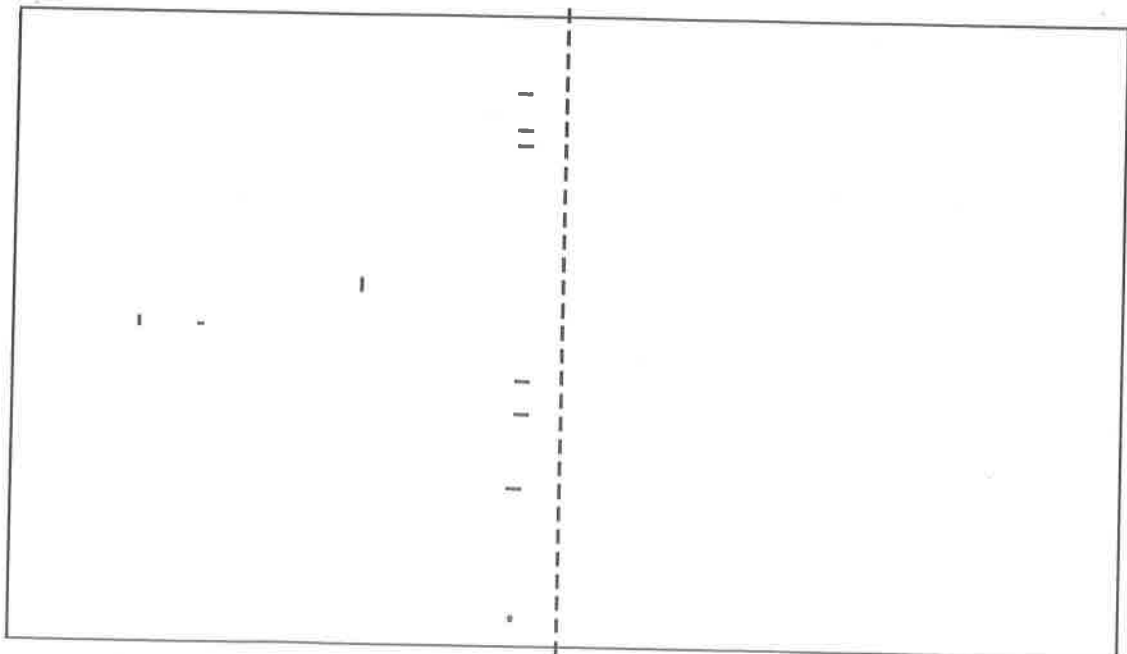

Name: _____

'U' SHAPE WORKSHEET "a"

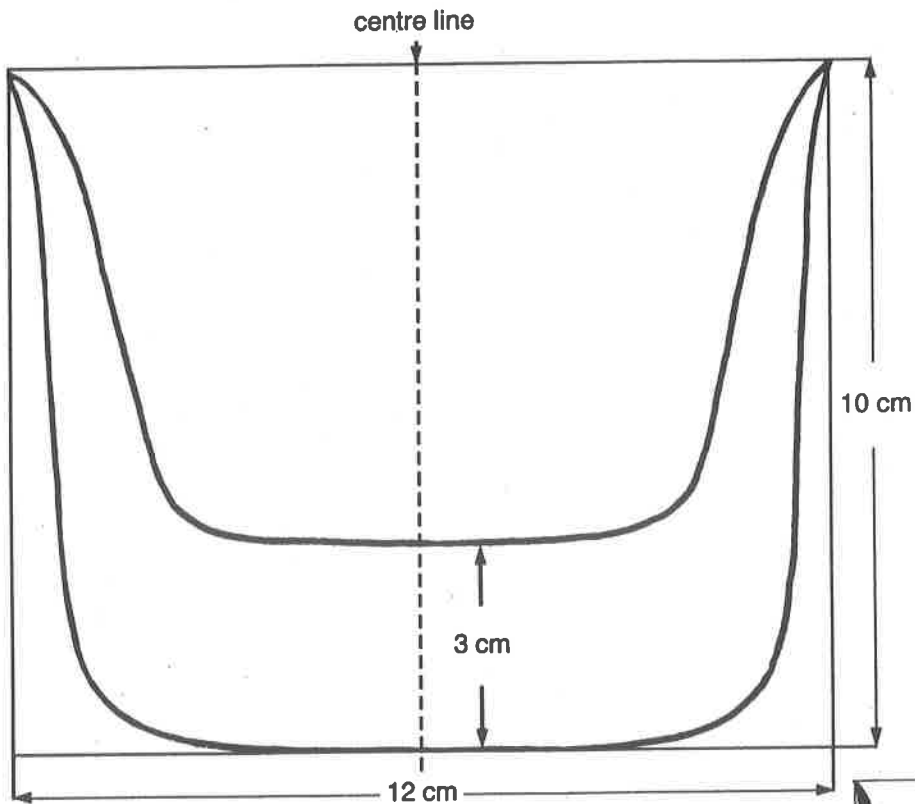

Connect the dots

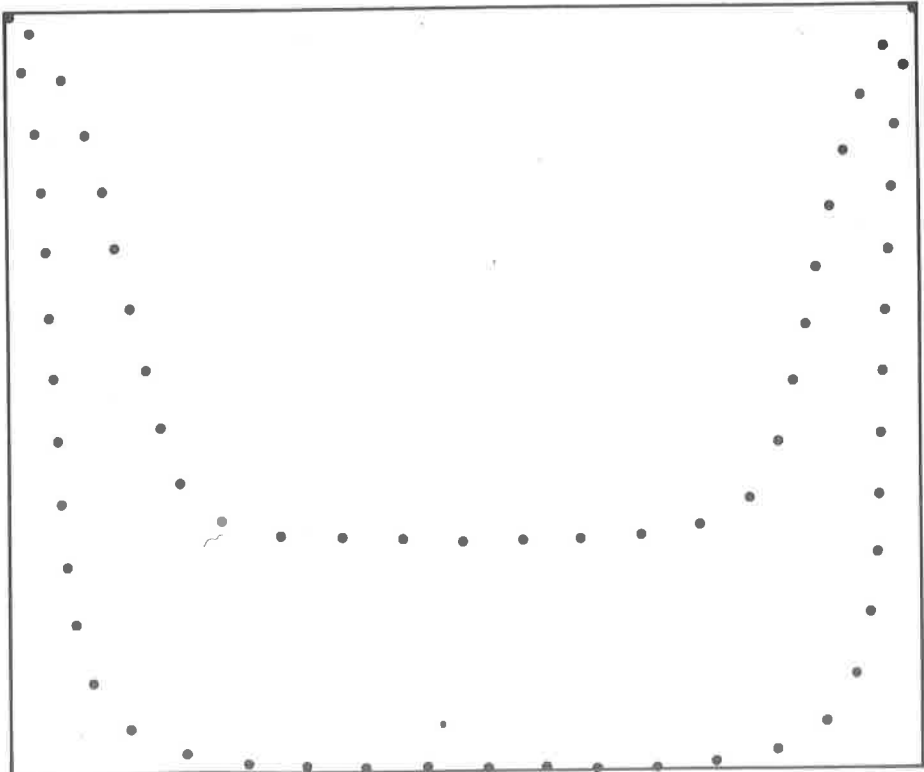

'U' SHAPE WORKSHEET "b"

Fill in the missing lines.

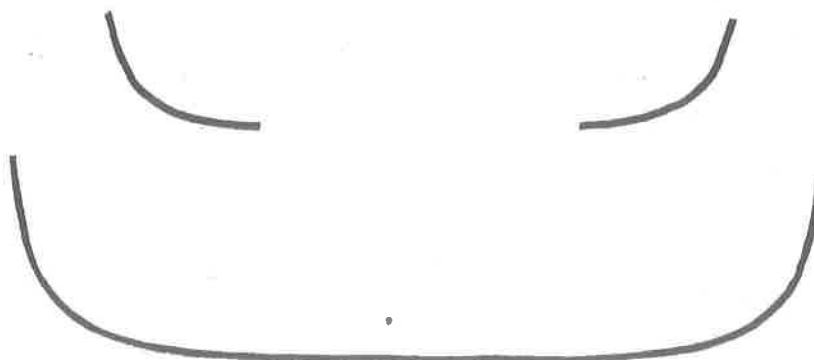
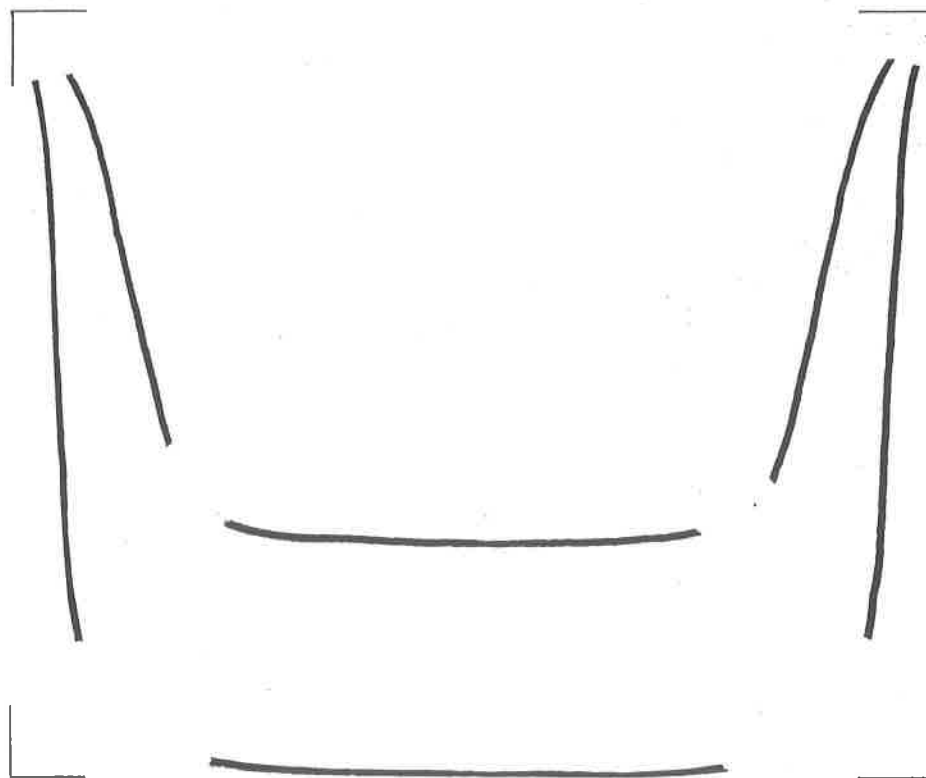

Name: _____

SPLIT 'U' WORKSHEET "a"

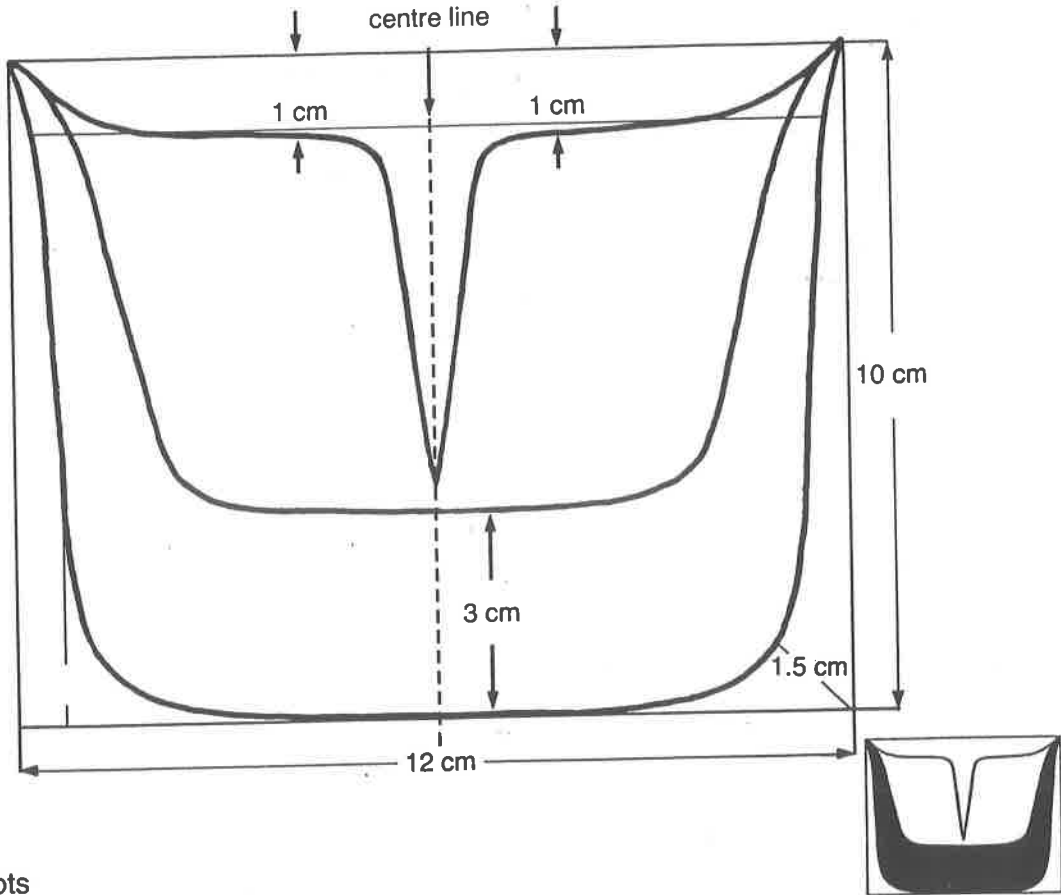

Connect the dots

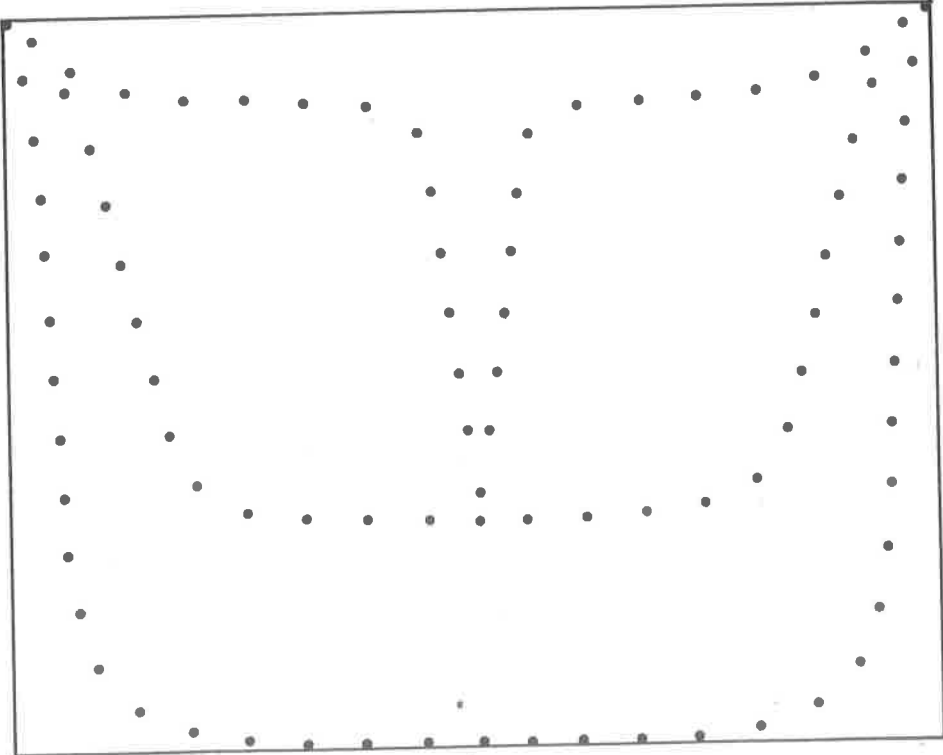

SPLIT 'U' WORKSHEET "b"

Fill in the missing lines

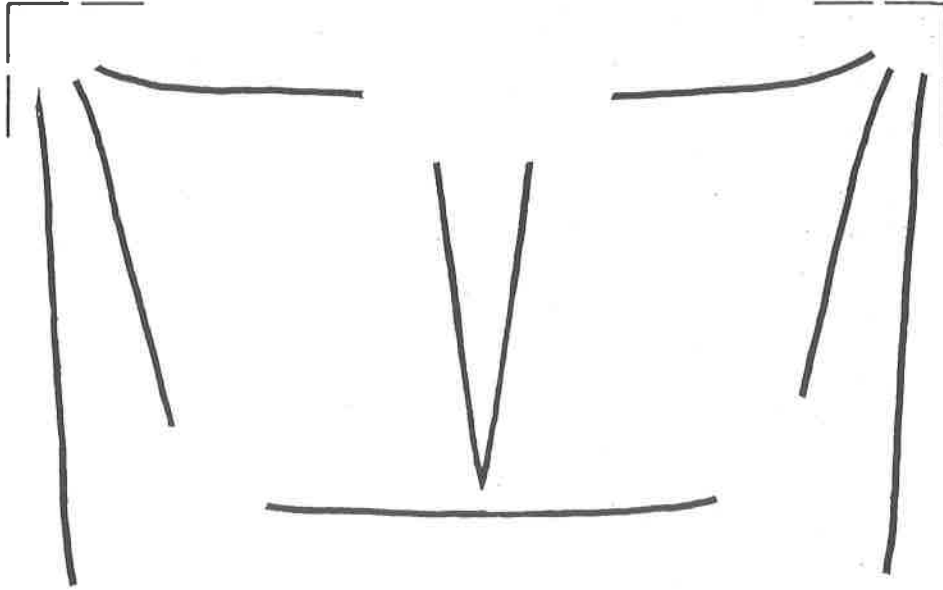

WHALE SHOWING OVOID COMPOSITION

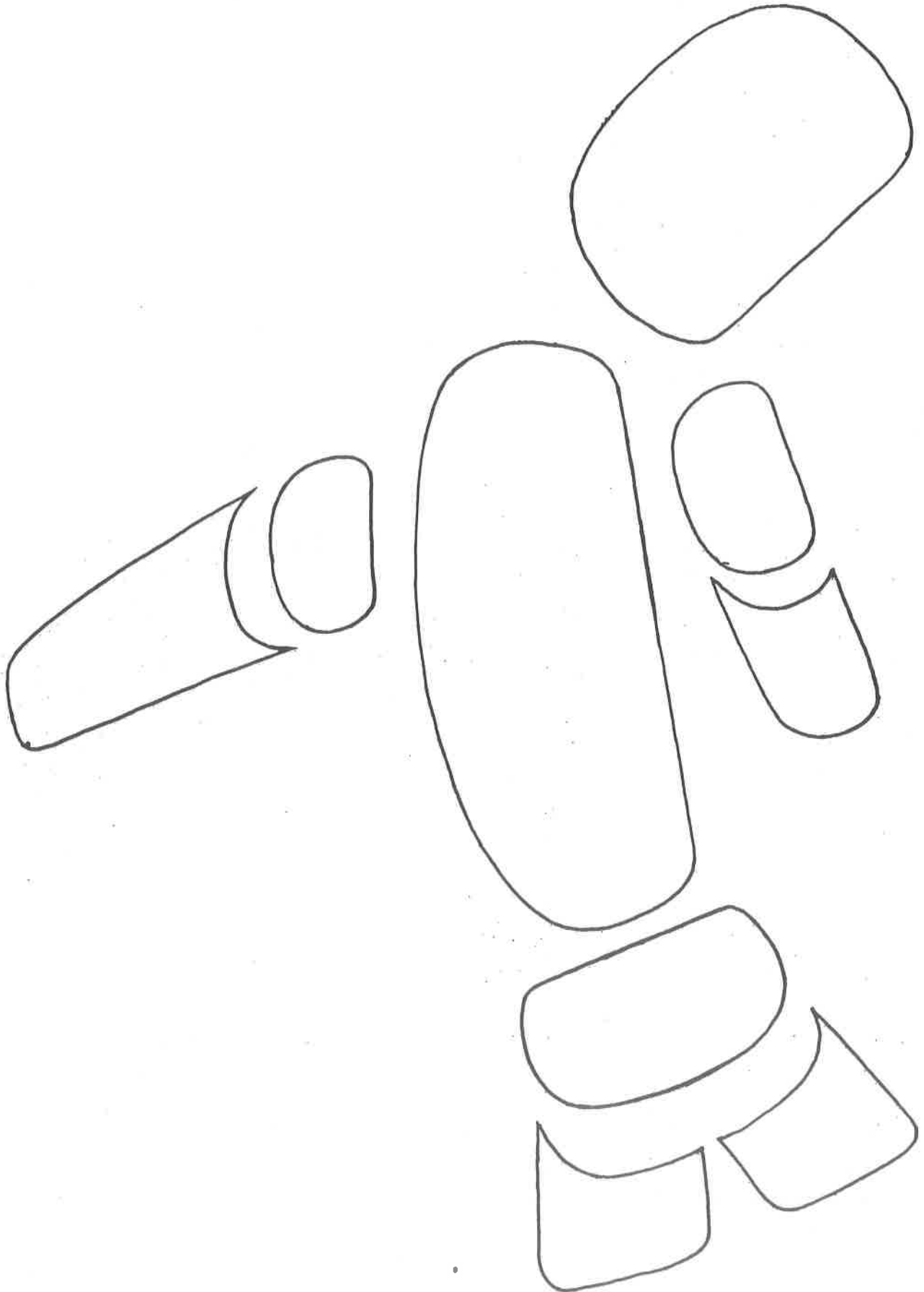

Name: _____

REVERSE SPLIT 'U' WORKSHEET "e"

